

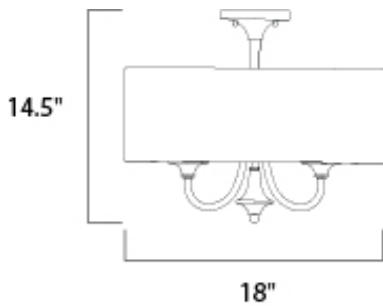

PRODUCT DESCRIPTION

This current trend collection of drum shade lighting is available in your choice of Oatmeal with Oil Rubbed Bronze or White Linen with Satin Nickel frames. This collection works in wide variety of decor styles from traditional to contemporary and comes at a very attractive price.





MEASUREMENTS

DIMENSION : 18" L x 18" W x 14.5" H
 CANOPY : 4.75" W x 1.97" H x 4.75" L
 HANGING WEIGHT : 5.9 lb

LAMPING

INPUT VOLTAGE : 120V
 BULB : 4 x 60W Incandescent E12 Candelabra , 240W Total
 BULB INCLUDED : (Not Included)
 DIMMABLE : Yes

FINISHES OPTION

-  Oil Rubbed Bronze (OI)
-  Satin Nickel (SN)

MATERIAL

Steel, Fabric

RATINGS

cETLus
 Dry Location



ADDITIONAL

ADJUSTABLE
 OPERATING TEMPERATURE:
 -20°C (-4°F), 40°C (104°F)

Always consult a qualified electrician before installing any lighting product.



WESTERN DISTRIBUTION CENTER (HEADQUARTER)
 253 NORTH VINELAND AVE | CITY OF INDUSTRY, CA 91746

EASTERN DISTRIBUTION CENTER
 101 GARDNER PARK | PEACHTREE CITY, GA 30269

P. 626.956.4200 | F. 626.956.4225 | maximlighting.com